

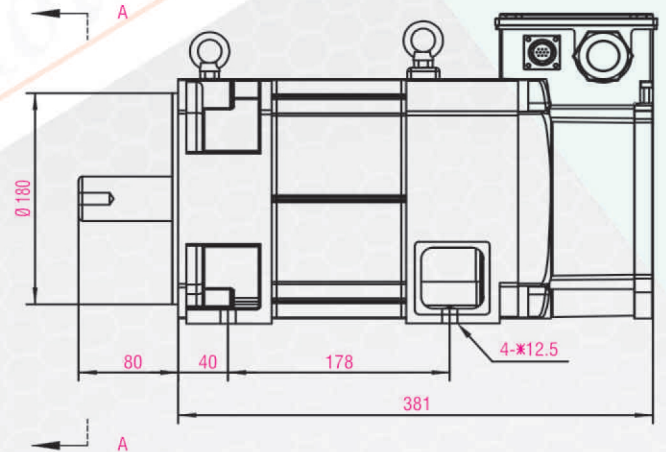

GL-B-40-1500

GABRIEL SERVO MOTOR

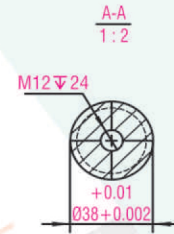
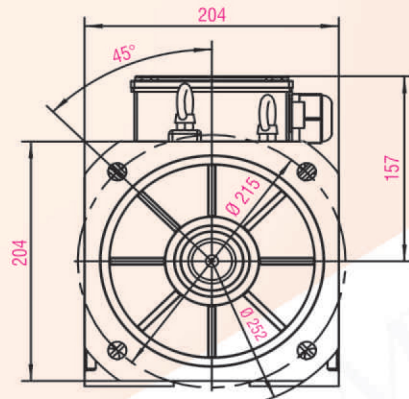
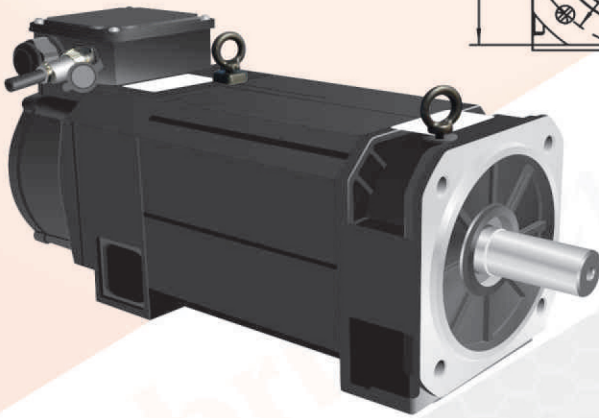

RATED POWER	4 Kw	STATOR RESISANCE	
RATED VOLTS	380 V	STATOR REACTANCE	
MODE OF CONNECTION	Y	ROTOR RESISANCE	
RATED FREQUENCY	50 Hz	ROTOR REACTANCE	
RATED CURRENT	9.6 A	EXCITATION REACTANCE	
RATED TORQUE	27 Nm	EXCITING REACTANCE	
REFERENCE SPEED	1460 r/min	INSULATION GRADE	F
MAX SPEED	6000 r/min	LEVEL OF PROTECTION	IP : 54
MOMENT OF INERTIA	0.0127 kg/m ²	SERIES	4 P
RATING	S1-%100	WEIGHT	40 Kgs.
COOLING FAN	RATED POWER	40 W	
	RATED VOLTS	380V 50/60Hz	
ENCODER	IMPULSES PER MINUTE	1024 PPR	
	OUTPUT MODE	HTL	
BRAKE RIGGING	NAME		
	THE DATA PARAMETER		

